

**FULGOR**  
MILANO

---

# Dishwasher

## *Instruction Manual*

DWF8010

- 14 place settings
- Alt function

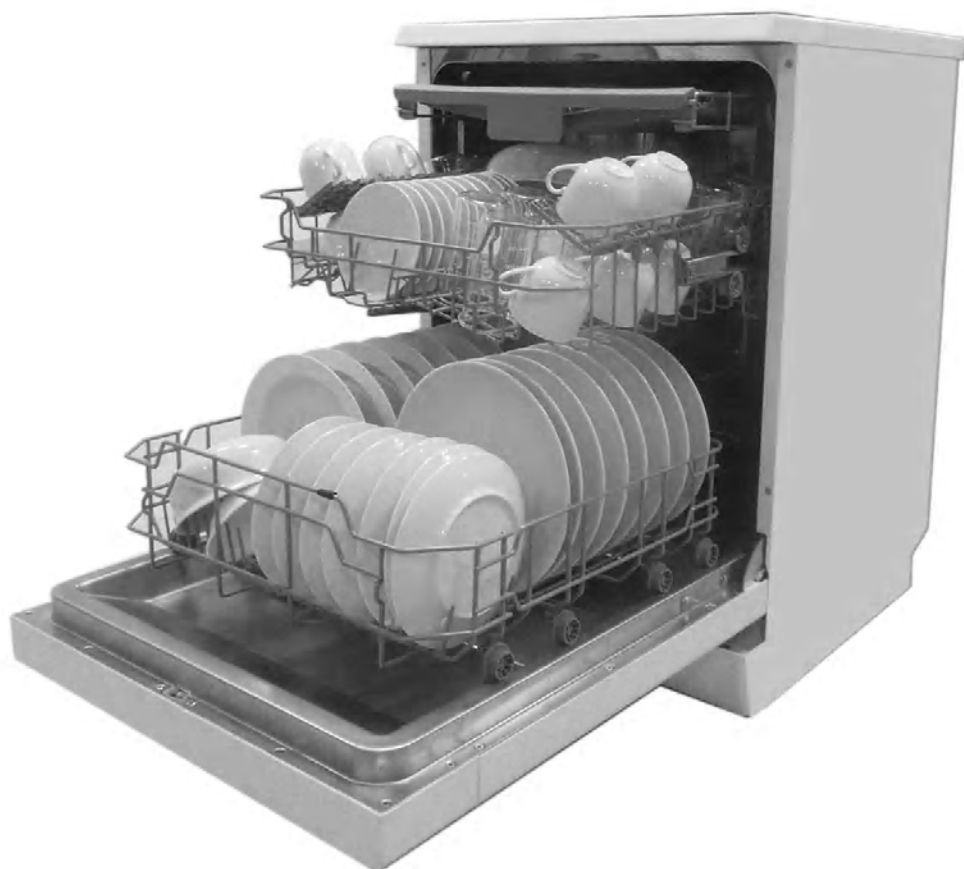

[www.fulgor.com.au](http://www.fulgor.com.au)

# Quick operation guide

For detailed operating method read the corresponding content on the instruction manual.

Switch on the appliance	Open the door, press the On/Off button to switch on the appliance.
Fill the detergent dispenser	<p><b>Compartment A:</b> With each wash cycle.</p> <p><b>Compartment B:</b> For programmes with pre-wash only. (Follow the user instructions!)</p>
Check the rinse aid level	<p><b>Mechanical Indicator C.</b> Electric indicator on control panel (if provided).</p>
Load the baskets	Scrape off any large amount of leftover food. Soften remnants of burnt food in pans, then load the baskets. Refer to the dishwasher loading instructions.
Select a programme	Press the Programme Button, the selected programme indicator lights up. ( See the section entitled “Operation instruction” )
Running the dishwasher	Close the door, turn on the water tap. The machine will start working after about 10 seconds.
<ul style="list-style-type: none"> <li>Changing the programme</li> <li>Add forgotten dishes in the dishwasher.</li> <li>If the appliance is switched off during a wash cycle.</li> </ul>	<ul style="list-style-type: none"> <li>1. A running cycle can only be modified if it has been running for a short time. Otherwise the detergent may have already been released and the water already drained. If this is the case, the detergent dispenser must be refilled.</li> <li>2. Open the door, press the program button more than 3 seconds, the machine will be in standby state, then you can change the program to the desired cycle setting.</li> <li>1. Open the door a little to stop the washing.</li> <li>2. After the spray arms stop working, you can open the door completely.</li> <li>3. Add forgotten dishes.</li> <li>4. Close the door, the dishwasher will run after 10 seconds.</li> <li>If the appliance is switched off during a wash cycle, when switched on again, please re-select the washing cycle and operate the dishwasher according to the original Power-on state.</li> </ul>
Switch off the appliance	When the working cycle has finished, the buzzer of the dishwasher will sound 8 times, then stop. Turn off the appliance using the On/Off Button.
Turn off the water tap, unload the baskets	Warning: wait a few minutes (about 15 minutes) before unloading the dishwasher to avoid handling the dishes and utensils while they are still hot and more susceptible to break. They will also dry better. Unload the appliance, starting from the lower basket.

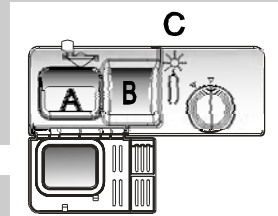

**⚠ WARNING!**  
Open the door carefully. Hot steam may escape when the door is opened!



## Read this Manual

Dear Customer,

This appliance is intended to be used in household and similar applications such as:

- staff kitchen areas in shops, offices and other working environments;
- farm houses;
- by clients in hotels, motels and other residential type environments;
- bed and breakfast type environments.

- Please carefully read this manual before using the dishwasher, it will help you to use and maintain the dishwasher properly.
- Keep it as a refer in the later days.
- Pass it on to any subsequent owner of the appliance.

This manual contains sections on safety Instructions, Operating Instructions, Installation Instructions and Troubleshooting Tips, etc.



## Before Calling for Service

- To review the section on troubleshooting Tips will help you to solve some common problems by yourself .
- If you can not solve the problems by yourself , please ask for the help of professional technicians.



## NOTE:

The manufacturer, following a policy of constant development and updating of the product, may make modifications without giving prior notice.

1) Safety Information.....	1
2) Operating Instructions.....	2
Control Panel.....	2
Dishwasher Features.....	2
3) Prior using for the first time.....	3
A、 Fill the Rinse Aid Dispenser.....	3
B、 Function of Detergent .....	4
4) Loading the Dishwasher Basket.....	6
Attention before or after loading the Dishwasher Baskets.....	6
The Method Loading Normal Dishware.....	7
5) Starting a washing programme.....	9
Wash Cycle Table.....	9
Turning on the Appliance.....	9
Change the Programme.....	10
At the End of the Wash Cycle.....	10
6) Maintenance and cleaning.....	11
Filtering System.....	11
Caring for the Dishwasher.....	12
7) Installation instruction.....	13
Positioning the Appliance.....	13
About Power Connection.....	13
Water Connection.....	14
Start of dishwasher.....	15
8) Troubleshooting Tips.....	16
Before calling for service.....	16
Error codes.....	17
Technical information.....	18

Loading the baskets according to (\*AS/NZS 2007.1)

# 1. IMPORTANT SAFETY INFORMATION

## READ ALL OF THE INSTRUCTIONS BEFORE USING

**⚠ WARNING!** When using your dishwasher, follow the precautions listed below:



### GROUNDING INSTRUCTIONS

- This appliance must be grounded. In the event of a malfunction or breakdown, grounding will reduce the risk of an electric shock by providing a path of least resistance of electric current. This appliance is equipped with a cord having an equipment-grounding conductor and a grounding plug.
- The plug must be plugged into an appropriate outlet that is installed and grounded in accordance with all local codes and ordinances.

### ⚠ WARNING!

- Improper connection of the equipment-grounding conductor can result in the risk of an electric shock.
- Check with a qualified electrician or service representative if you are in doubt whether the appliance is properly grounded. Do not modify the plug provided with the appliance; If it does not fit the outlet. Have a proper outlet installed by a qualified electrician.



### WARNING! PROPER USE

- Do not abuse, sit on, or stand on the door or dish rack of the dishwasher.
- Do not operate your dishwasher unless all enclosure panels are properly in place. Open the door very carefully if the dishwasher is operating, there is a risk of water squirting out.
- Do not place any heavy objects on or stand on the door when it is open. The appliance could tip forward.
- When loading items to be washed:
  - 1) Locate sharp items so that they are not likely to damage the door seal;
  - 2) Warning: Knives and other utensils with sharp points must be loaded in the basket with their points down or placed in a horizontal position.
- Check that the detergent compartment is empty after completion of the wash cycle.
- Do not wash plastic items unless they are marked dishwasher safe or the equivalent. For plastic items not so marked, check the manufacturer's recommendations.
- Use only detergent and rinse additives designed for an automatic dishwasher.
- Never use soap, laundry detergent, or hand washing detergent in your dishwasher. Keep these products out of the reach of children.
- Keep children away from detergent and rinse aid, keep children away from the open door of the dishwasher, there could still be some detergent left inside.
- This appliance is not intended for use by persons (including children) with reduced physical, sensory or mental capabilities, or lack of experience and knowledge, unless they have been given supervision or instruction concerning use of the appliance by a person responsible for their safety.
- Children should be supervised to ensure that they do not play with the appliance.
- Dishwasher detergents are strongly alkaline, they can be extremely dangerous if swallowed. Avoid contact with skin and eyes and keep children away from the dishwasher when the door is open.
- The door should not be left open, since this could increase the risk of tripping.
- If the supply cord is damaged, it must be replaced by the manufacturer or its service agent or a similarly qualified person in order to avoid a hazard.
- Remove the door to the washing compartment when removing an old dishwasher from service or discarding it.
- Please dispose of packing materials properly.
- Use the dishwasher only for its intended function.
- During installation, the power supply must not be excessively or dangerously bent or flattened.
- Do not tamper with controls.  
The appliance is to be connected to the water mains using new hose sets and that old hose-sets should not be reused.
- The maximum number of place settings to be washed is 14.
- The maximum permissible inlet water pressure is 1Mpa.
- The minimum permissible inlet water pressure is 0.04Mpa.

**READ AND FOLLOW THIS SAFETY INFORMATION CAREFULLY**  
**KEEP THESE INSTRUCTIONS**

## 2. Operation Instruction

**! IMPORTANT** To get the best performance from your dishwasher, read all operating instructions before using it for the first time.

### Control Panel

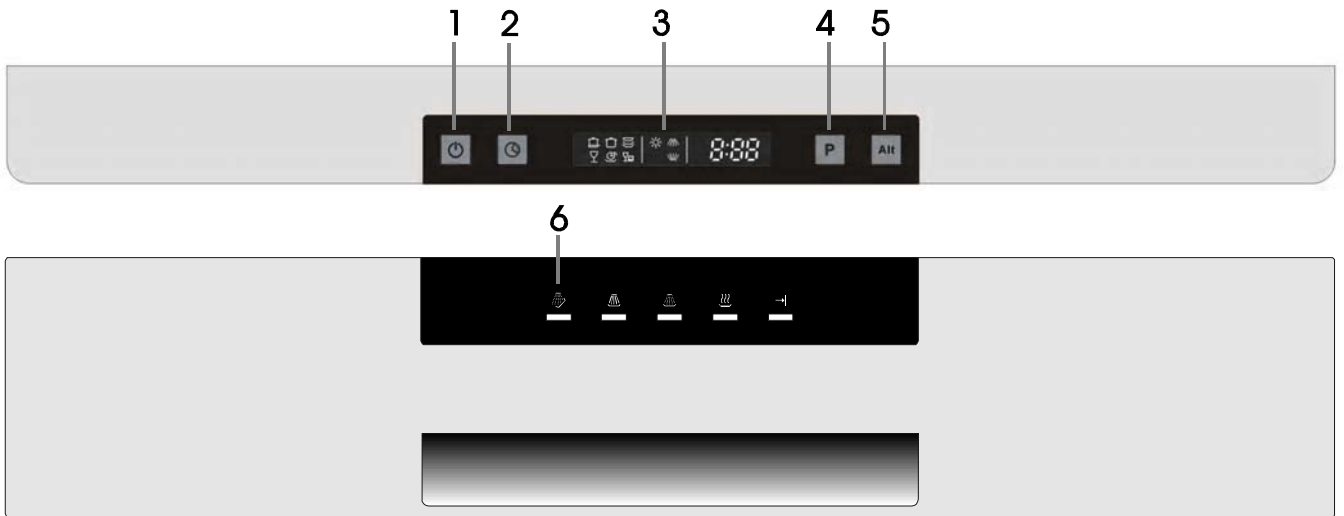

**1** On/Off Button: To turn on/off the power supply.

**2** Delay Button : To Press the button to delay.

**3** Display screen: to show the remaining time and the state(running state, delay time etc )

• Program indicators: 

• Rinse Aid indicator:  Indicates when the dispenser needs to be refilled.





• Delay time ,Remain time ,or error codes indicator: 

• Alt function indicator: 

**4** Program Button : To Press the button to select appropriate Program.

**5** Alt Button: Dual zone wash function, press the button to select either upper basket or lower basket loaded, and the response indicator .

**6** Program step indicators:

- Pre-wash indicator: 
- Main-wash indicator: 
- Rinse indicator: 
- Drying indicator: 
- Program end indicator: 

### Dishwasher Features

Front view

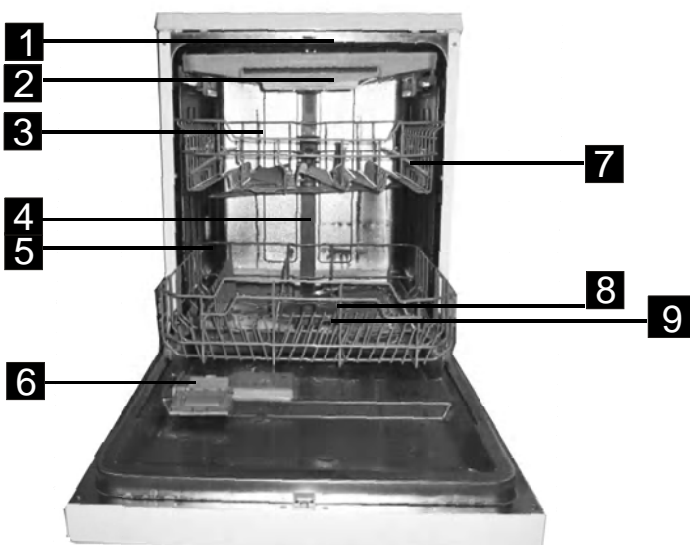

Back View



**1** Top spray arm

**2** Cutlery rack

**3** Upper basket

**4** Inner pipe

**5** Lower basket

**6** Dispenser

**7** Cup shelf

**8** Spray arms

**9** Filter assembly

**10** Inlet pipe connector

**11** Drain pipe

### 3. Prior using for the first time

Before using your dishwasher for the first time:

- A** Fill the rinse aid dispenser
- B** Fill in detergent

## A. Fill the Rinse Aid Dispenser

### Rinse Aid Dispenser

The rinse aid is released during the final rinse to prevent water from forming droplets on your dishes, which can leave spots and streaks. It also improves drying by allowing water to roll off the dishes. Your dishwasher is designed to use liquid rinse aids. The rinse aid dispenser is located inside the door next to the detergent dispenser. To fill the dispenser, open the cap and pour the rinse aid into the dispenser until the level indicator turns completely black. The volume of the rinse aid container is about 110ml.

### Function of Rinse Aid

Rinse aid is automatically added during the last rinse, ensuring thorough rinsing, and spot and streak free drying.

### Attention!

Only use branded rinse aid for dishwasher. Never fill the rinse aid dispenser with any other substances (e.g. Dishwasher cleaning agent, liquid detergent). This would damage the appliance.

## When to Refill the Rinse Aid Dispenser

If there is no rinse-aid warning light in the control panel, you can judge the amount of rinse-aid by the color of the optical level indicator "C" located next to the cap. When the rinse-aid container is full, the whole indicator will be dark. As the rinse-aid diminishes, the size of the dark dot decreases. You should never let the rinse aid get below 1 / 4 full.

As the rinse aid diminishes, the size of the black dot on the rinse aid level indicator changes, as illustrated below.

- Full
- 3 / 4 full
- 1 / 2 full
- 1 / 4 full - Should refill to eliminate spotting
- Empty

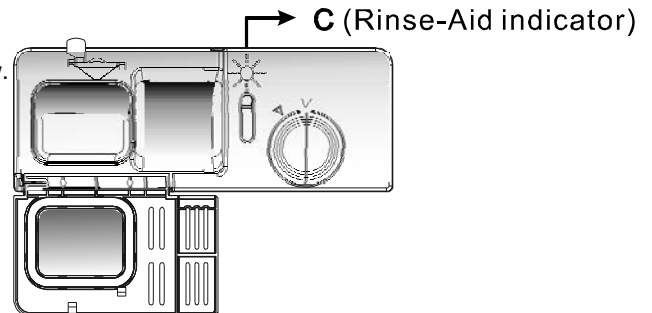

## RINSE AID DISPENSER

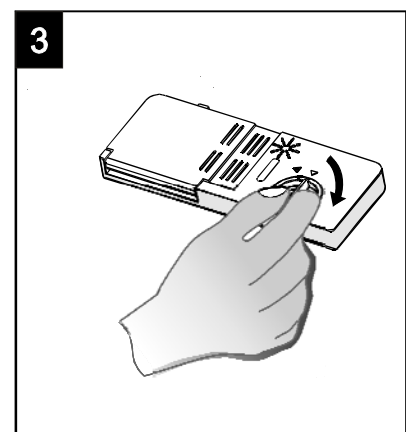
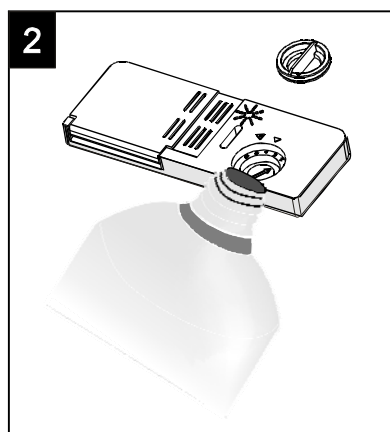
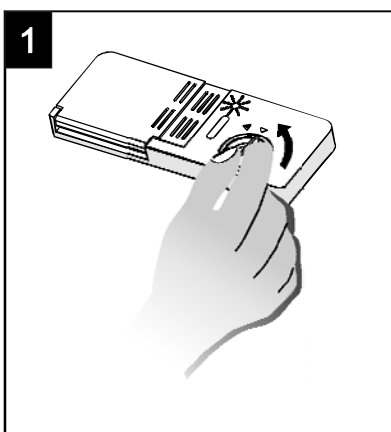

- 1** To open the dispenser, turn the cap to the "open" (left) arrow and lift it out.
- 2** Pour the rinse aid into the dispenser, being careful not to overfill.
- 3** Replace the cap by inserting it aligned with "open" arrow and turning it to the closed (right) arrow.

Be careful not to overfill the dispenser, because this could cause over sudsing. Wipe away any spills with a damp cloth. Don't forget to replace the cap before you close dishwasher door.

Attention!

Clean up any rinse aid spill during filling with an absorbent cloth to avoid excess foaming during the next wash.

**NOTE:** Clean up any rinse aid spilled while during filling with an absorbent cloth to avoid excessive foaming during the next wash. Don't forget to replace the cap before you close dishwasher door.

## Adjusting Rinse Aid Dispenser

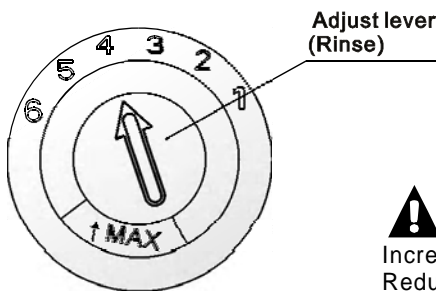

The rinse aid dispenser has six or four settings. Always start with the dispenser set on "4". If spots and poor drying are a problem, increase the amount of rinse aid dispensed by removing the dispenser lid and rotating the dial to "5". If the dishes still are not drying properly or show spots, adjust the dial to the next higher lever until your dishes are spot-free. The recommended setting is "4". (Factory value is "4".)

**NOTE:**

Increase the dose if there are drops of water or lime spots on the dishes after washing. Reduce it if there are sticky whitish stains on your dishes or a bluish film on glassware or knife blades.

## B. Function of Detergent

Detergents with its chemical ingredients are necessary to remove dirt, crush dirt and transport it out of the dishwasher. Most of the commercial quality detergents are suitable for this purpose.

### Detergents

There are 3 sorts of detergents

1. With phosphate and with chlorine
2. With phosphate and without chlorine
3. Without phosphate and without chlorine

Normally new pulverised detergent is without phosphate. Thus the water softener function of phosphate is not given. In this case we recommend to fill salt in the salt container even when the hardness of water is only 6 °dH. If detergents without phosphate are used in the case of hard water often white spots appear on dishes and glasses. In this case please add more detergent to reach better results. Detergents without chlorine do only bleach a little. Strong and coloured spots will not be removed completely. In this case please choose a program with a higher temperature.

### Concentrated Detergent

Based on their chemical composition, detergents can be split in two basic types:

- conventional, alkaline detergents with caustic components
- low alkaline concentrated detergents with natural enzymes

The use of "normal" washing programs in combination with concentrated detergents reduces pollution and is good for your dishes; these wash programs are specifically matched to the dirt-dissolving properties of the enzymes of the concentrated detergent. For this reason "normal" wash programs in which concentrated detergents are used can achieve the same results that can otherwise only be achieved using "intensive" programs.

### Detergent Tablets

Detergent tablets of different brands dissolve at different speeds. For this reason some detergent tablets cannot dissolve and develop their full cleaning power during short programs. Therefore please use long programs when using detergent tablets, to ensure the complete removal of detergent residuals.

### Detergent Dispenser

The dispenser must be refilled before the start of each wash cycle following the instructions provided in the wash cycle table. Your dishwasher uses less detergent and rinse aid than conventional dishwasher. Generally, only one tablespoon of detergent is needed for a normal wash load. More heavily soiled items need more detergent. Always add the detergent just before starting the dishwasher, otherwise it could get damp and will not dissolve properly.

# Amount of Detergent to Use

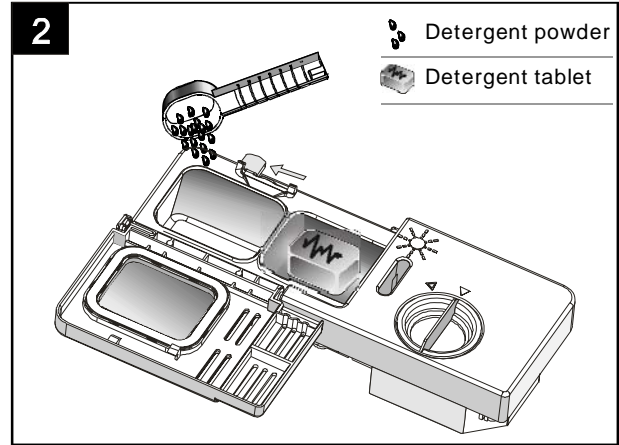
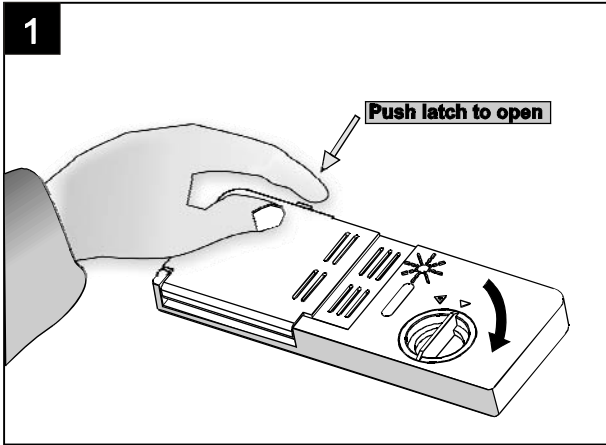

## **!** NOTE:

- If the lid is closed: press release button. The lid will spring open.
- Always add the detergent just before starting each wash cycle.
- Only use branded detergent aid for dishwasher.

## **!** WARNING!

Dishwasher detergent is corrosive! Take care to keep it out of reach of children.

### Proper Use of Detergent

Use only detergent specifically made for the use in dishwashers. Keep your detergent fresh and dry. Don't put powdered detergent into the dispenser until you're ready to wash dishes.

## Fill in Detergent

Fill the detergent dispenser with detergent. The marking indicates the dosing levels, as illustrated on the right:

- A** The place of main wash cycle detergent placed.
- B** The place of pre-wash cycle detergent placed.

Please observe the manufacturers dosing and storage Recommendations as stated on the detergent packaging.

Close the lid and press until it locks in place.

If the dishes are heavily soiled, place an additional detergent dose in the pre-wash detergent chamber. This detergent will take effect during the pre-wash phase.

## **!** NOTE:

- You find information about the amount of detergent for the single programme on the last page.
- Please aware, that according to the level soiling and the specific hardness of water differences are possible.
- Please observe the manufacturer's recommendations on the detergent packaging.

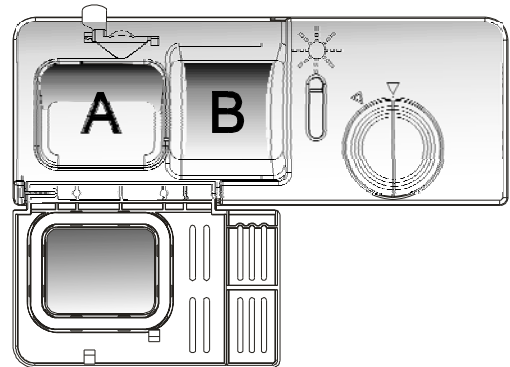



## 4. Loading the Dishwasher Baskets

### Recommendation

- Consider buying utensils which are identified as dishwasher-proof.
- Use a mild detergent that is described as 'kind to dishes'. If necessary, seek further information from the detergent manufacturers.
- For particular items, select a program with as low a temperature as possible.
- To prevent damage, do not take glass and cutlery out of the dishwasher immediately after the programme has ended.

### For washing in the dishwasher the following cutlery/dishes

#### Are not suitable

- Cutlery with wooden, horn china or mother-of-pearl handles
- Plastic items that are not heat resistant
- Older cutlery with glued parts that are not temperature resistant
- Bonded cutlery items or dishes
- Pewter or cooper items
- Crystal glass
- Steel items subject to rusting
- Wooden platters
- Items made from synthetic fibres

#### Are of limited suitability

- Some types of glasses can become dull after a large number of washes
- Silver and aluminum parts have a tendency to discolour during washing
- Glazed patterns may fade if machine washed frequently

### Attention before or after loading the Dishwasher Baskets

(For best performance of the dishwasher, follow these loading guidelines.  
Features and appearance of baskets and cutlery baskets may vary from your model.)

Scrape off any large amounts of leftover food. Soften remnants of burnt food in pans.  
It is not necessary to rinse the dishes under running water.

Place objects in the dishwasher in following way:

1. Items such as cups, glasses, pots/pans, etc. are faced downwards.
2. Curved items, or ones with recesses, should be loaded aslant so that water can run off.
3. All utensils are stacked securely and can not tip over.
4. All utensils are placed in the way that the spray arms can rotate freely during washing.



**NOTE:** Very small items should not be washed in the dishwasher as they could easily fall out of the basket.

- Load hollow items such as cups, glasses, pans etc. With the opening facing downwards so that water cannot collect in the container or a deep base.
- Dishes and items of cutlery must not lie inside one another, or cover each other.
- To avoid damage to glasses, they must not touch.
- Load large items which are most difficult to clean into the lower basket.
- The upper basket is designed to hold more delicate and lighter dishware such as glasses, coffee and tea cups
- Long bladed knives stored in an upright position are a potential hazard!
- Long and/or sharp items of cutlery such as carving knives must be positioned horizontally in the upper basket.
- Please do not overload your dishwasher. This is important for good results and for reasonable consumption of energy.

### Removing the Dishes

To prevent water dripping from the upper basket into the lower basket, we recommend that you empty the lower basket first and then the upper basket.

# ■ The Method Loading Normal Dishware

## Loading the Upper Basket

The upper basket is designed to hold more delicate and lighter dishware such as glasses, coffee and tea cups and saucers, as well as plates, small bowls and shallow pans (as long as they are not too dirty). Position the dishes and cookware so that they will not get moved by the spray of water.

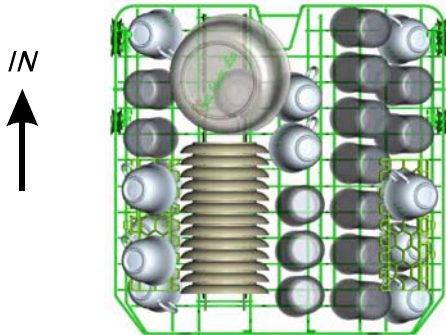

Please be reminded that:

- Pots, serving bowls, etc, must always be placed top down.
- Deep pots should be slanted to allow water to flow out.
- The Bottom Basket features folding spikes so that larger or more pots and pans can be loaded.

## Loading the Lower Basket

We suggest that you place large items and the most difficult to clean items are to be placed into the lower basket: such as pots, pans, lids, serving dishes and bowls, as shown in the figure below. It is preferable to place serving dishes and lids on the side of the racks in order to avoid blocking the rotation of the top spray arm.

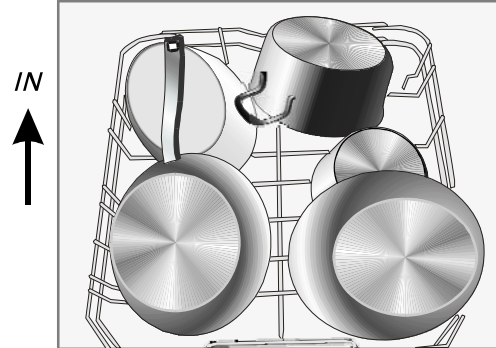

## Adjusting the Upper Basket

The height of the upper basket can be adjusted in order to create more space for large utensils both for the upper /lower basket. The height of the upper basket can be adjusted by lift up the basket for the upper position, and up press the handle to lower the upper basket, see the picture below:

Lift the basket for upper position

Up press the handle to lower the basket



Adjust handle

## Folding back the cup shelives

For better stacking of pots and pans, the spikes can be folded down as show in the picture right.

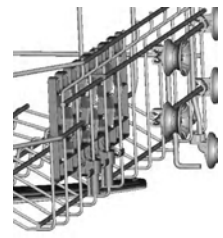
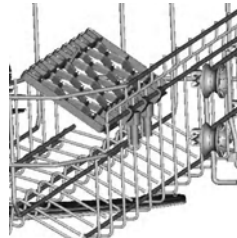

## Folding Spikes of Lower Basket

For better stacking of pots and pans, the spikes can be folded down as show in the picture right.



## Cutlery Basket

Cutlery should be placed in the cutlery rack separately from each other in the appropriate positions, and do make sure the utensils do not nest together, this may cause bad performance.

For a top quality cleaning, place the silverware in the basket making sure that:

- They do not nest together.
- Silverware is placed with the male face up.
- Long utensils in the middle.

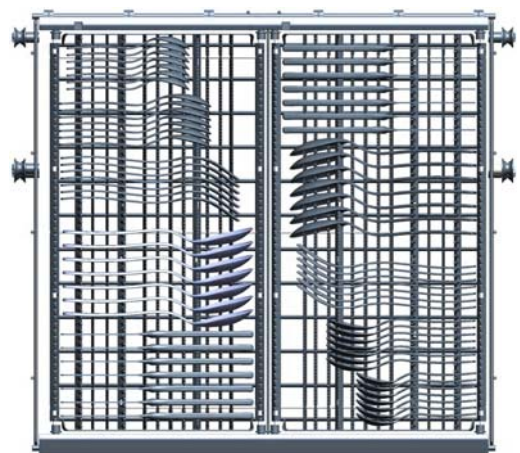

## Cutlery basket has 5 positions:

### Mode 1

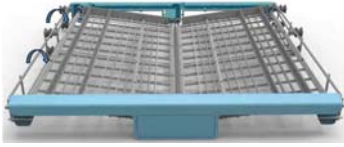

Position one: lift the left basket up, both left and right baskets are slanting.

### Mode 2



Position two: adjust the left basket to lower position, left basket is flat and right basket is slanting.

### Mode 3

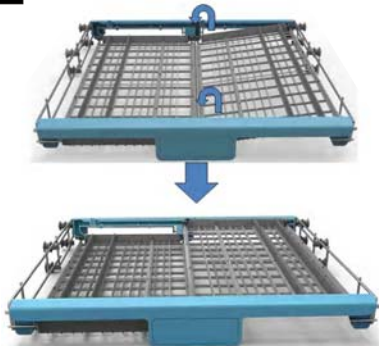

Position three: lift the right basket up, both left and right baskets are flat.

### Mode 4

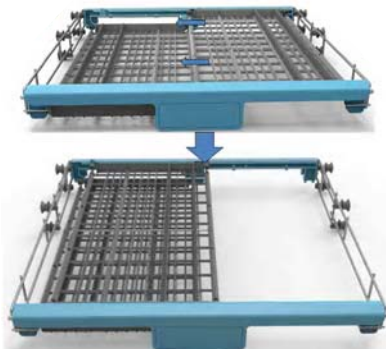

Position Four: Move the right basket from right to left, two baskets are overlapping.

### Mode 5









Position Five: Remove the right basket from the tray, only has the left basket.

## 5. Starting a washing program

### Wash Cycle Table

**!** **NOTE:** (★) Means: need to fill rinse into the Rinse-Aid Dispenser.

Program	Cycle Selection Information	Description of Cycle	Detergent pre/main	Running time(min)	Energy (Kwh)	Water (L)	Rinse Aid
Intensive 	For the heaviest soiled loads, such as pots, pans, casserole dishes and dishes that have been sitting with dried food on them for a while.	Pre-wash(50°C) Wash (65 °C) Rinse Rinse(55°C) Drying	$\frac{5}{27.5g}$ (Or All in 1)	165	1.4	16.5	★
Heavy 	For heavily soiled loads, such as pots, plates, glasses and lightly soiled pans.	Pre-wash(45 °C) Wash (55 °C) Rinse Rinse (60 °C) Drying	$\frac{5}{27.5g}$ (Or All in 1)	175	1.2	13.5	★
Normal  <small>(*AS/NZS 2007.1)</small>	Standard daily cycle for normally soiled loads, such as pots, plates, glasses.	Pre-wash Wash (45 °C) Rinse Rinse(50°C) Drying	$\frac{5}{27.5g}$ (Or All in 1)	165	0.74	12.6	★
Glass 	For lightly soiled crockery and glass	Pre-wash wash(40°C) Rinse Rinse(60°C) Drying	20g	115	0.85	13.5	★
1Hour 	For lightly soiled loads that do not need excellent drying efficiency.	Pre-wash(50°C) Wash(60°C) Rinse (50°C) Drying	$\frac{5}{27.5g}$	60	0.85	9	★
Rapid 	A shorter wash for lightly soiled loads and quick wash.	Wash (40 °C) Rinse Rinse (45 °C)	20g	35	0.5	10	

**!** **NOTE:**

\*AS/NZS 2007.1 : This program is the test cycle. The information for comparability test in accordance with AS/NZS 2007.1 , as follows:

- Capacity: 14 setting
- Position Upper basket: upper wheels on rails
- Rinse aid setting: 6
- Open the door slightly 50mm to assist in drying of the dishes after every wash

## Turning On the Appliance

Starting a cycle wash

- Draw out the lower and upper basket, load the dishes and push them back.  
It is commended to load the lower basket first, then the upper one (see the section entitled “Loading the Dishwasher” ).
- Pour in the detergent (see the section entitled “Detergent and Rinse Aid” ).
- Insert the plug into the socket. The power supply is 220-240 VAC /50 HZ, the specification of the socket is 10A 250VAC. Make sure that the water supply is turned on to full pressure.
- Open the door, press the ON/OFF Button, and the display will turn on.
- Press the program Button to selected your desired program.  
If a program is selected, the response light will light. Then close the door, the dishwasher begins to start.

## Change the Program...

Premise:

- ❶ A cycle that is underway can only be modified if it has only been running for a short time. Otherwise, the detergent may have already been released, and the appliance may have already drained the wash water. If this is the case, the detergent dispenser must be refilled (see the section entitled " Loading the Detergent " ).
- ❷ Open the door , the machine will pause, press the program button more than 3s then you can change the program to the desired cycle setting (see the section entitled " Starting a wash cycle. . ." ).



### **NOTE:**

*If you open the door during a wash cycle , the machine will pause. The program light will stop blinking and the buzzer will mooring every minute unless you close the door . After you close the door ,the machine will keep on working after 10 seconds.*

## Forgot to Add a Dish?

A forgotten dish can be added any time before the detergent cup opens.

- ❶ Open the door a little .
- ❷ After the spray arms stop working, you can open the door completely.
- ❸ Add forgotten dishes.
- ❹ Close the door, the dishwasher will run after 10 seconds.

## At the End of the Wash Cycle

When the working cycle has finished, the buzzer of the dishwasher will sound for 8 seconds, then stop. Turn off the appliance using the ON/OFF button, shut off the water supply and open the door of the dishwasher. Wait for a few minutes before unloading the dishwasher to avoid handling the dishes and utensils while they are still hot and more susceptible to breakage. They will also dry better.

### ■ Switch Off the Dishwasher

The program light is on but is not blinking, only in this case the programme has ended.

- 1.Switch off the dishwasher by pressing the ON/OFF button.
- 2.Turn off the water tap!

### ■ Open the door carefully.

Hot dishes are sensitive to knocks. The dishes should therefore be allowed to cool down around 15 minutes before removing from the appliance.

Open the dishwasher's door, leave it ajar and wait a few minutes before removing the dishes. In this way they will be cooler and the drying will be improved.

### ■ Unloading the dishwasher

It is normal that the dishwasher is wet inside.

Empty the lower basket first and then the upper one. This will avoid water dripping from the upper Basket onto the dishes in the lower one.

### **⚠ WARNING!**

It is dangerous to open the door when washing, because the hot water may scald you.

# 6. Maintenance and Cleaning

## Filtering System

The filter prevents larger remnants of food or other objects from getting inside the pump. The residues may block the filter, in this case they must be removed.

The filter system consists of a coarse filter, a flat (Main filter) And a microfilter(Fine filter).

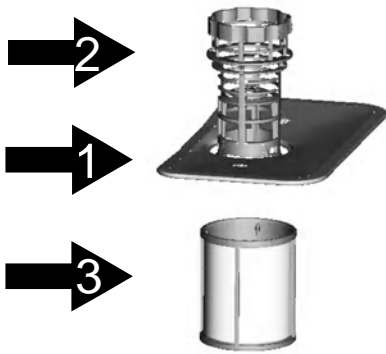

### Main filter **1**

Food and soil particles trapped in this filter are pulverized by a special jet on the lower spray arm and washed down to drain.

### Coarse filter **2**

Larger items, such as pieces of bones or glass, that could block the drain are trapped in the coarse filter. To remove the items caught by the filter, gently squeeze the tap on the top of this filter and lift out.

### Fine filter **3**

This filter holds soil and food residues in the sump area and prevents it from being redeposit on the dishes during wash cycle.

## Filter assembly

The filter efficiently removes food particles from the wash water, allowing it to be recycled during the cycle. For best performance and results, the filter must be cleaned regularly. For this reason, it is a good idea to remove the larger food particles trapped in the filter after each wash cycle by rinsing the semicircular filter and cup under running water. To remove the filter device, pull the cup handle in the upward direction.

### **⚠ WARNING!**

- The dishwasher must never be used without the filters.
- Improper replacement of the filter may reduce the performance level of the appliance and damage dishes and utensils.

**1**



Step 1: Turn the filter in anti-clockwise direction,

**2**



Step 2: lift the filter assy up



**NOTE:** *When following this procedure from step1 to step 2, the filter system will be removed; when following it from Step 2 to Step 1, the filter system will be installed.*

## Remarks:

- Inspect the filters for blocking after every time the dishwasher has been used.
- By unscrewing the coarse filter, you can remove the filter system. Remove any food remnants and clean the filters under running water.

**⚠ NOTE:** The entire filter assembly should be cleaned once a week.

## Cleaning the Filter

To clean the coarse filter and the fine filter, use a cleaning brush. Reassemble the filter parts as shown in the figures on the last page and reinsert the entire assembly in the dishwasher, positioning it in its seat and pressing downwards.

**⚠ WARNING!** When cleaning the filters, don't knock on them. Otherwise, the filters could be contorted and the performance of the dishwasher could be decreased.

## Caring for the Dishwasher

The control panel can be cleaned by using a lightly dampened cloth. After cleaning, make sure to dry it thoroughly.

For the exterior, use a good appliance polish wax.

Never use sharp objects, scouring pads or harsh cleaners on any part of the dishwasher.

## Cleaning The Door

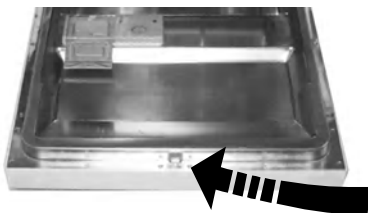

To clean the edge around the door, you should use only a soft warm, damp cloth. To avoid penetration of water into the door lock and electrical components, do not use a spray cleaner of any kind.

**⚠ WARNING!**

- Never use a spray cleaner to clean the door panel as it may damage the door lock and electrical components.
- Abrasive agents or some paper towels should not be used because of the risk of scratching or leaving spots on the stainless steel surface.

## Protect Against Freezing

please take frost protection measures on the dishwasher in winter. Every time after washing cycles, please operate as follows:

1. Cut off the electrical power to the dishwasher.
2. Turn off the water supply and disconnect the water inlet pipe from the water valve.
3. Drain the water from the inlet pipe and water valve. (Use a pan to gather the water)
4. Reconnect the water inlet pipe to the water valve.
5. Remove the filter at the bottom of the tub and use a sponge to soak up water in the sump.

**⚠ NOTE:** If your dishwasher cannot work because of the ice, please contact professional service persons.

## Cleaning the Spray Arms

It is necessary to clean the spray arms regularly for hard water chemicals will clog the spray arm jets and bearings.

To remove the upper spray arm, hold the nut, rotate the arm clockwise to remove it.

To remove the lower spray arm, pull out the spray arm upward.

Wash the arms in soapy and warm water and use a soft brush to clean the jets. Replace them after rinsing them thoroughly.

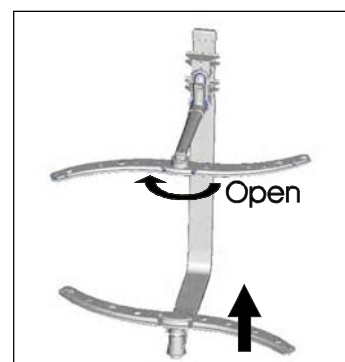

# How to Keep Your Dishwasher in Shape

## ■ After Every Wash

After every wash, turn off the water supply to the appliance and leave the door slightly open so that moisture and odours are not trapped inside.

## ■ Remove the Plug

Before cleaning or performing maintenance, always remove the plug from the socket.

## ■ No Solvents or Abrasive Cleaning

To clean the exterior and rubber parts of the dishwasher, do not use solvents or abrasive cleaning products. Only use a cloth with warm soapy water. To remove spots or stains from the surface of the interior, use a cloth dampened with water and a little vinegar, or a cleaning product made specifically for dishwashers.

## ■ When not in Use for a Long Time

It is recommended that you run a wash cycle with the dishwasher empty and then remove the plug from the socket, turn off the water supply and leave the door of the appliance slightly open. This will help the door seals to last longer and prevent odours from forming within the appliance.

## ■ Moving the Appliance

If the appliance must be moved, try to keep it in the vertical position. If absolutely necessary, it can be positioned on its back.

## ■ Seals

One of the factors that cause odours to form in the dishwasher is food that remains trapped in the seals. Periodic cleaning with a damp sponge will prevent this from occurring.

## 7. Installation instruction

### Positioning the Appliance

Position the appliance in the desired location. The back should rest against the wall behind it, and the sides, along the adjacent cabinets or walls. The dishwasher is equipped with water supply and drain hoses that can be positioned either to the right or the left sides to facilitate proper installation.

### Levelling the Appliance

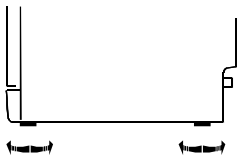

Once the appliance is positioned for levelling, the height of the dishwasher may be altered via adjustment of the screwing level of the feet. In any case, the appliance should not be inclined more than 2°.

### About Power Connection

#### ⚠ WARNING!

For personal safety:

- DO NOT USE AN EXTENSION CORD OR AN ADAPTER PLUG WITH THIS APPLIANCE.
- DO NOT, UNDER ANY CIRCUMSTANCES, CUT OR REMOVE THE EARTHING CONNECTION FROM THE POWER CORD.

### Electrical Requirements

Please look at the rating label to know the rating voltage and connect the dishwasher to the appropriate power supply. Use the required fuse 10 amp, time delay fuse or circuit breaker recommended and provide separate circuit serving only this appliance.

### Electrical Connection

#### ⚠ Insure proper ground exists before use

Ensure the voltage and frequency of the power being corresponds to those on the rating plate. Only insert the plug into an electrical socket which is earthed properly. If the electrical socket to which the appliance must be connected is not appropriate for the plug, replace the socket, rather than using a adaptors or the like as they could cause overheating and burns.



## GROUNDING INSTRUCTIONS

- This appliance must be earthed. In the event of a malfunction or breakdown, earthing will reduce the risk of electric shock by providing a path of least resistance for the electric current. This appliance is equipped with a cord having an equipment-earthing conductor and an earthing plug. The plug must be plugged into an appropriate outlet that is installed and earthed in accordance with all local standards and requirements.



- ⚠ WARNING!**
- Improper connection of the equipment earthing conductor can result in the risk of an electric shock.
  - Check with a qualified electrician or service representative if you are in doubt whether the appliance is properly earthed.
  - Do not modify the plug provided with the appliance. If the plug does not fit properly to the outlet, please have a qualified electrician to install a proper outlet.

## Water Connection

### *How to Connect the safety supply hose*

---

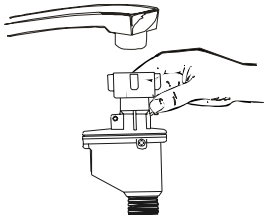

The appliance must be connected to the water mains using new hose-sets. The old hose-sets should not be reused.

Water pressure must be between 0,04 MPa and 1 MPa. If the pressure is below the minimum consult our Service Department for advice.

- 1 Pull The safety supply hoses completely out from storage compartment located at rear of dishwasher.
- 2 Tighter the screws of the safety supply hose to the faucet with thread 3/4inch.
- 3 Turn water fully on before starting the dishwasher.

### **ABOUT THE SAFETY SUPPLY HOSE.**

The safety supply hose consists of the double walls. The hose's system guarantees its intervention by blocking the flow of water in case of the supply hose breaking and when the air space between the supply hose itself and the outer corrugated hose is full of water.

#### **⚠ WARNING!**

A hose that attaches to a sink spray can burst if it is installed on the same water line as the dishwasher. If your sink has one, it is recommended that the hose be disconnected and the hole plugged.

### *How to Disconnect the safety supply hose*

---

- 1 Turn off the water.
- 2 Release the water pressure by depressing the pressure release button. This relieves water pressure and protects you, and the room, from severe splashing.
- 3 Unscrew the safety supply hose from the faucet.

## **COLD WATER CONNECTION**

---

Connect the cold water supply hose to a threaded 3/4(inch) connector and make sure that it is fastened tightly in place. If the water pipes are new or have not been used for an extended period of time, let the water run to make sure that the water is clear and free of impurities. If this precaution is not taken, there is a risk that the water inlet can get blocked and damage the appliance.

## Drain hose Connection

Insert the drain hose into a drain pipe with a minimum diameter of 40mm, or let it run into the sink, making sure to avoid bending or crimping it. The top of the hose must be less than 1000mm.

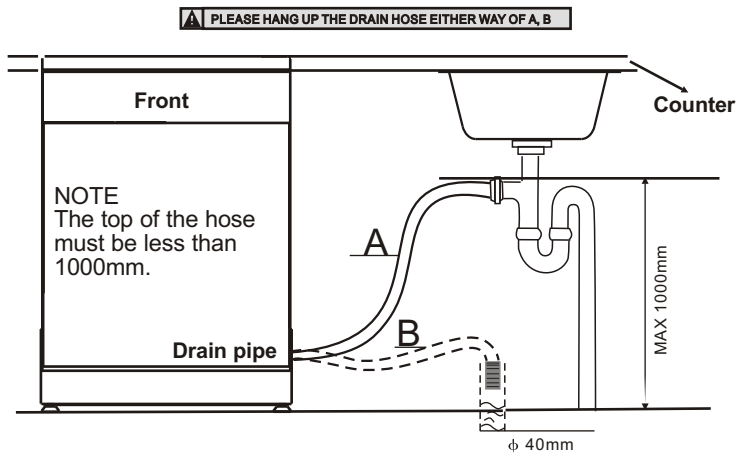

## How to Drain Excess Water From Hoses

If the sink is 1000 higher from the floor, the excess water in hoses cannot be drained directly into the sink. It will be necessary to drain excess water from hoses into a bowl or suitable container that is held outside and lower than the sink.

## Water Outlet

Connect the water drain hose. The drain hose must be correctly fitted to avoid water leaks. Ensure that the water drain hose is not kinked or squashed.

## Extension Hose

If you need a drain hose extension, make sure to use a similar drain hose. It must be no longer than 4 metres; otherwise the cleaning effect of the dishwasher could be reduced.

## Syphon Connection

The waste connection must be at a height less than 1000 mm (maximum) from the bottom of the dish. The water drain hose should be fixed.

## Start of Dishwasher

The following things should be checked before starting the dishwasher.

- 1 The dishwasher is level and fixed properly
- 2 The inlet valve is open
- 3 The power plug is correctly plugged in
- 4 The power is switched on
- 5 The inlet and drain hoses are connected
- 6 All packing materials and printings should be taken out from the dishwasher

**⚠ Attention:** After installation, please make sure to keep this manual.  
The content of this manual is very helpful to the users.

# 8. Troubleshooting Tips

## Before Calling for Service

Review the charts on the following pages may save you from calling for service.



	<i>Problem</i>	<i>Possible Causes</i>	<i>What To Do</i>
Technical problems	<i>Dishwasher doesn't start</i>	Fuse blown, or the circuit breaker tripped	Replace fuse or reset circuit breaker. Remove any other appliances sharing the same circuit with the dishwasher
		Power supply is not turned on	Make sure the dishwasher is turned on and the door is closed securely. Make sure the power cord is properly plugged into the wall socket.
		Error code:E1; Water pressure is low	Check that the water supply is connected properly and the water is turned on.
		Door of dishwasher not properly closed.	Make sure to close the door properly and latch it.
	<i>water not pumped from dishwasher</i>	Kink in drain hose	Check drain hose.
		Filter clogged	Check coarse the filter (see section titled "Cleaning The Filter ")
		Kitchen sink clogged	Check the kitchen sink to make sure it is draining well. If the problem is the kitchen sink not draining ,you may need a plumber rather than a serviceman for dishwashers.
General problems	<i>Suds in the tub</i>	Improper detergent	Use only the special dishwasher detergent to avoid suds. If this occurs, open the dishwasher and let suds evaporate. Add 4 litres of cold water to the tub. Close and latch the dishwasher, then select any cycle. Dishwasher will drain out the water at the first step. Open the door after draining is stop and check if the suds have disappeared. Repeat if necessary.
		Spilled rinse-aid	Always wipe up rinse-aid spills immediately.
	<i>Stained tub interior</i>	Detergent with colourant was used	Make sure that the detergent is the one without colourant.
	<i>White film on inside surface</i>	Hard water minerals	To clean the interior, use a damp sponge with dishwasher detergent and wear rubber gloves. Never use any other cleaner than dishwasher detergent for the risk of foaming or suds.
	<i>There are rust stains on cutlery</i>	The affected items are not corrosion resistant.	
		A programme was not run after dishwasher salt was added. Traces of salt have gotten into the wash cycle.	Always run the quick wash programme . without any crockery in the dishwasher and without selecting the Turbo function (if present), after adding dishwasher salt.
The lid of the softer is loose		Check the lid .Ensure it is correctly closed.	
Noise	<i>Knocking noise in the wash cabinet</i>	A spray arm is knocking against an item in a basket	Interrupt the programme, and rearrange the items which are obstructing the spray arm.
	<i>Rattling noise in the wash cabinet</i>	Items of crockery are loose in the wash cabinet	Interrupt the programme, and rearrange the items of crockery.
	<i>Knocking noise in the water pipes</i>	This may be caused by on-site installation or the cross-section of the piping.	This has no influence on the dishwasher function. if in doubt, contact a suitably qualified plumber.



Unsatis-  
-factory  
washing  
result

<i>Problem</i>	<i>Possible Causes</i>	<i>What To Do</i>
<i>The dishes are not clean</i>	The dishes were not loaded correctly.	See notes in " Loading the Dishwasher Baskets ".
	The programme was not powerful enough.	Select a more intensive programme. See" Wash Cycle Table ".
	Not enough detergent was dispensed.	Use more detergent, or change your detergent.
	Items are blocking the path of spray arms.	Rearrange the items so that the spray arm can rotate freely.
	The filter combination in the base of wash cabinet is not clean or is not correctly fitted. This may cause the spray arm jets to get blocked.	Clean and/or fit the filter combination correctly. Clean the spray arm jets. See "Cleaning the Spray Arms".
<i>Cloudiness on glassware</i>	Combination of soft water and too much detergent.	Use less detergent if you have soft water and select a shortest cycle to wash the glassware and to get them clean.
<i>Black or gray marks on dishes</i>	Aluminum utensils have rubbed against dishes.	Use a mild abrasive cleaner to eliminate those marks.
<i>Detergent left in dispenser cups</i>	Dishes block detergent cups.	Re-loading the dishes properly.

Unsatis-  
-factory  
drying  
result

<i>The dishes are not drying</i>	Improper loading	Load the dishwasher as suggested in the directions.
	Too little rinse-aid	Increase the amount of rinse-aid/refill the rinse-aid dispenser.
	Dishes are removed too soon	Do not empty your dishwasher immediately after washing. Open the door slightly so that the steam can escape. Begin unloading the dishwasher only once the dishes are barely warm to the touch. Empty the low basket first. This prevents water from dropping off dishes in the upper basket.
	Wrong program has been selected	In short program the washing temperature is lower. This also lowers cleaning performance. Choose a program with a long washing time.
	Use of cutlery with a low-quality coating	Water drainage is more difficult with these items. Cutlery or dishes of this type are not suitable for washing in the dishwasher.

## Error Codes

When some malfunctions come on, the appliance will display error codes to warn you:

<i>Codes</i>	<i>Meanings</i>	<i>Possible Causes</i>
E1	Longer inlet time.	Faucets is not opened, or water intake is restricted, or water pressure is too low.
E4	Overflow.	Some element of dishwasher leaks .
E8	Failure of orientation of distributary valve.	Open circuit or break of distributary valve.

**⚠ WARNING!**

- If overflow occurs, turn off the main water supply before calling a service.
- If there is water in the base pan because of an overflow or small leak, the water should be removed before restarting the dishwasher.

## Technical Information

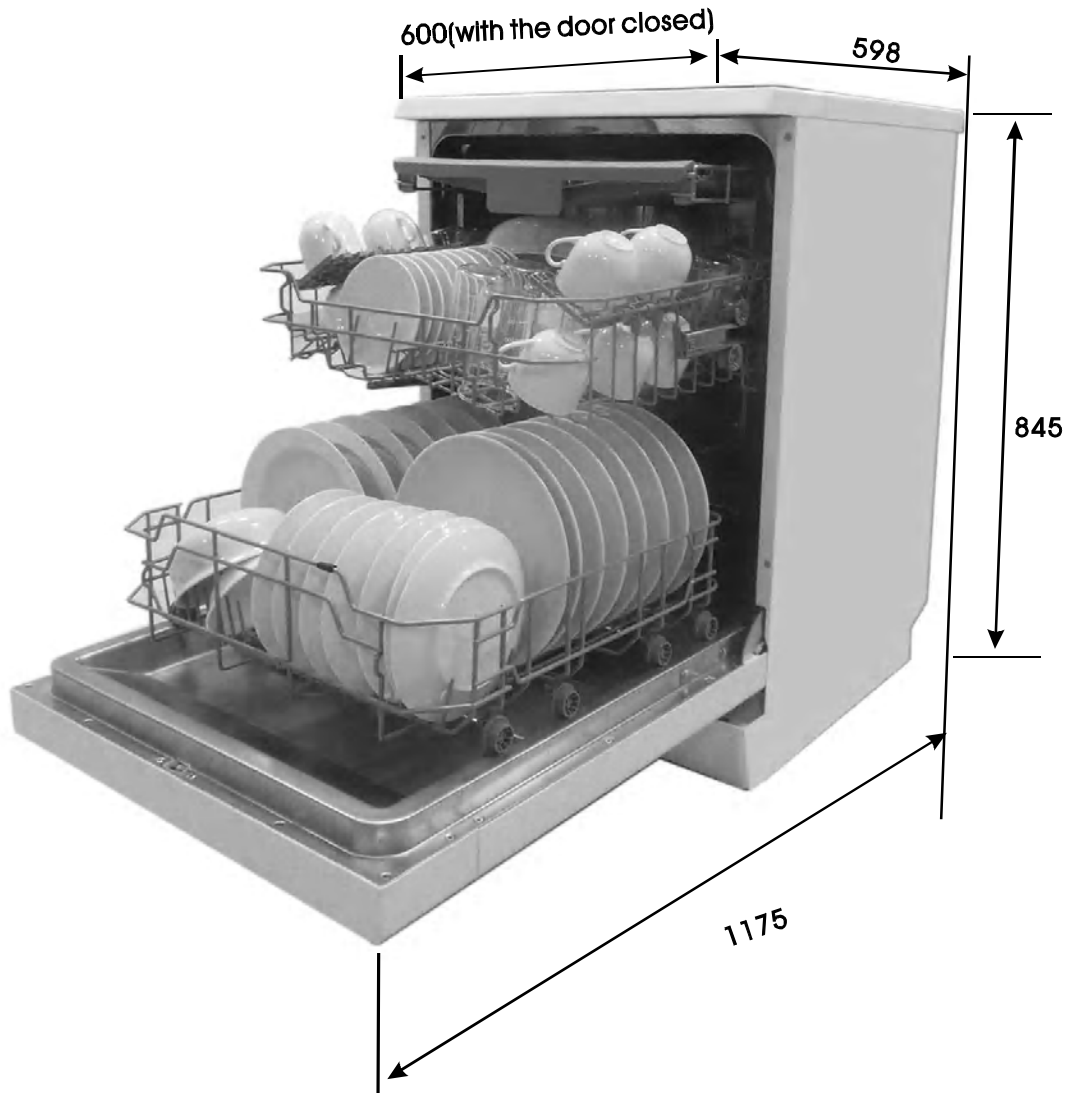

Height :	845mm
Width :	598 mm
Depth :	600mm(with the door closed)
Water pressure:	0.04-1.0MPa
Power supply:	see rating label
Capacity:	14 place settings

**Loading the baskets according to (\*AS/NZS 2007.1) :**

**1.Upper basket:**

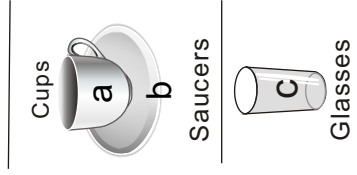
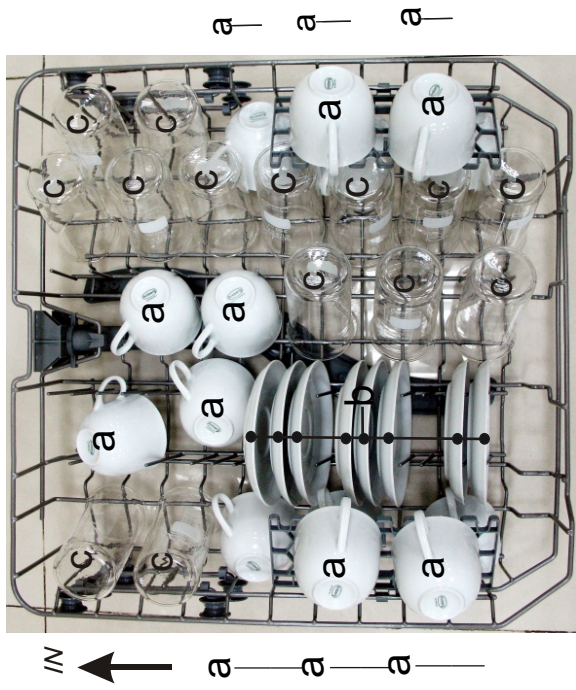

**2.Lower basket:**

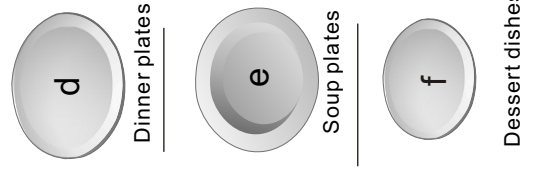
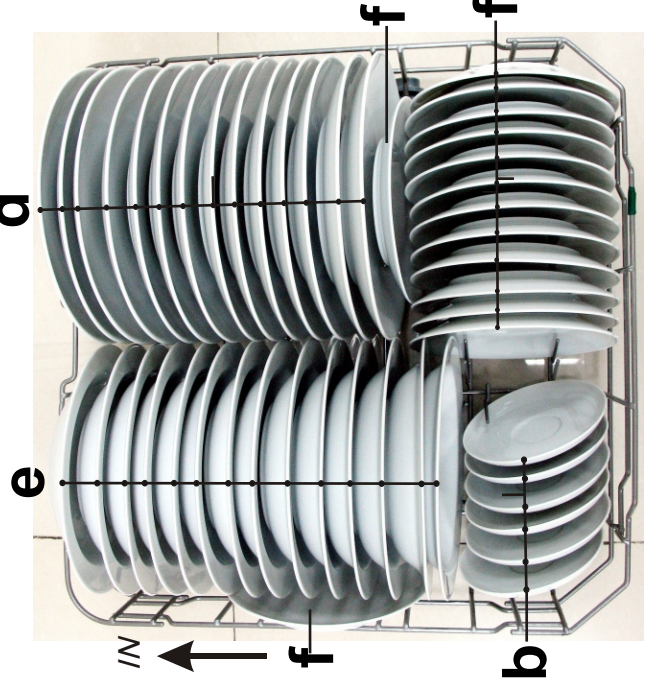

**3.Cutterly basket:**

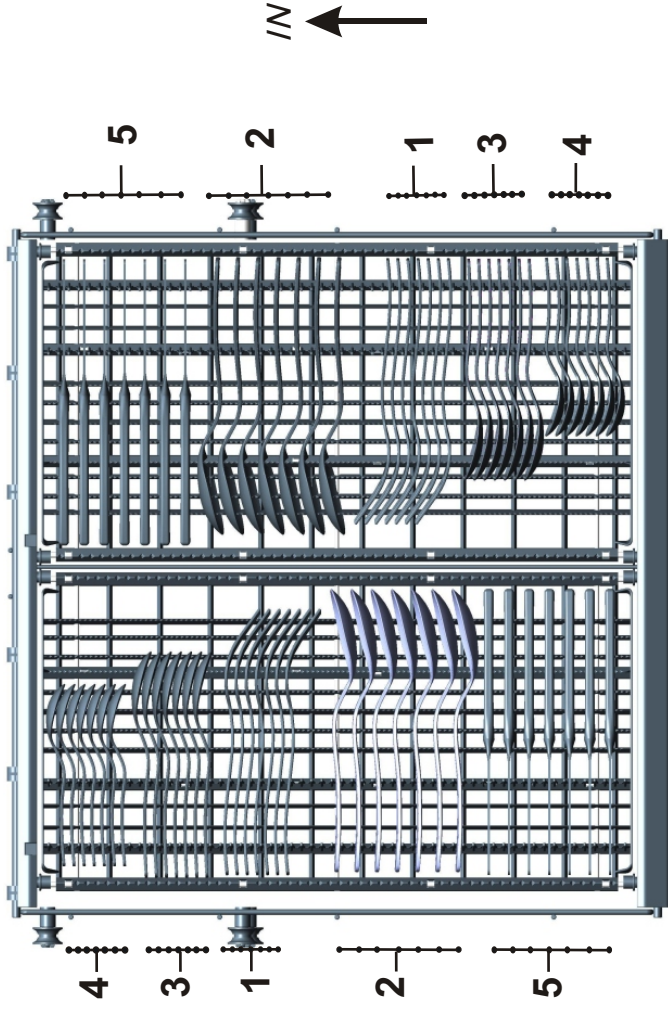

- 1 Forks
- 2 Soup spoons
- 3 Dessert spoons
- 4 Teaspoons
- 5 Knives

Information for comparability tests in accordance with (\*AS/NZS 2007.1)

- Voltage:230V/50Hz
- Capacity: 14 place settings
- Position of the upper basket: lower
- Programme: Normal
- Detergent(Pre/main): 5 g/27.5 g
- Rinse aid setting: 6